



CLICK&FLOOR
DUNE



CLICK&FLOOR

**2 ¿POR QUÉ CLICK&FLOOR?
*WHY CLICK&FLOOR?***

4 ROBLE

12 SIERRA

20 MULTI NOGAL

26 CHEVRON

**32 CONSEJOS DE INSTALACIÓN
*INSTALLATION ADVICES***

**39 PIEZAS ESPECIALES
*SPECIAL PIECES***

**40 EMBALAJE
*PACKAGING***

**40 CÓDIGOS DE VENTA
*SALES CODES***

**40 SÍMBOLOS DE EMBALAJE
*PACKAGING SYMBOLS***

¿POR QUÉ CLICK&FLOOR? / WHY CLICK&FLOOR?

Su núcleo a base mineral y su capa de protección aportan unas prestaciones de resistencia y estabilidad muy superiores a las del vinilo estándar LVT, ofreciendo múltiples ventajas.

Its mineral-based core and its protective layer provide resistance and stability benefits far superior to those of standard LVT vinyl, offering multiple advantages.



Sin cola
Glueless



Fácil de instalar
Easy to install

- ① Capa de protección UV (cuarzo y uretano) / *UV protection layer (quartz and urethan)*
- ② Capa de desgaste 0.55mm ultra resistente / *0.55mm Ultra-resistant wear layer EIR embossing*
- ③ Capa decorativa con relieve sincronizado / *Deep structured decorative layer*
- ④ Núcleo rígido a base de piedra caliza <65% y PVC >35% / *Rigid core limestone-based <65% and PVC > 35%*
- ⑤ Capa de insonorización de 1mm (material virgen IXPE-P) / *1mm IXPE soundproof backing*



Textura con aspecto natural
Texture with natural look



Apto para toda la casa.
Perfect for the whole house.

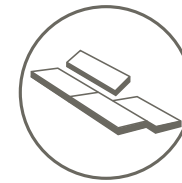

Sistema click extra hermético
Extra hermetic click system



Apto para suelo radiante
Suitable for underfloor heating

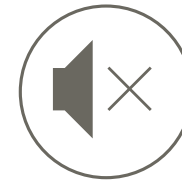

Reducción acústica
Reduction acoustics



Apto para mascotas
Pet friendly

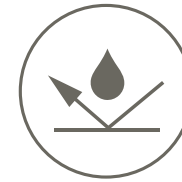

100% Impermeable
100% Waterproof



Ultra resistente
Extra resistant

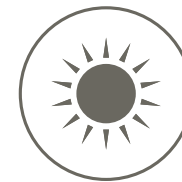

Estable al calor y a la luz solar
Stable to heat and sunlight



Fácil limpieza
Easy to clean

30
Year
Residential

15
Year
Light Commercial



FÁCIL Y PRÁCTICO de instalar, se puede colocar sobre la mayoría de suelos sin apenas preparación. Su sistema de click hermético refuerza la unión entre lamas, permitiendo una instalación rápida y segura. Fácil de mantener y de limpiar con aspiradores, fregasuelos y productos convencionales. Es la solución perfecta para reformas rápidas de hogares y locales comerciales, sin suciedad ni ruidos molestos. Se coloca y ya está listo para usar.

EASY AND PRACTICAL to install, Click&Floor can be laid over most pre-existing floors with little preparation. Its hermetic click system reinforces the joints between slats, allowing a quick and safe installation. Easy to maintain and to clean, just with vacuums, mops and conventional cleaners. A perfect solution for quick renovations of homes and commercial premises, without dirt or annoying noise. Ready to use just after installaton.



CONFORTABLE Y ACOGEDOR Andar descalzo sobre Click&Floor es un auténtico placer. Cálido y agradable como la madera natural y, a la vez, técnico y silencioso gracias a su aislamiento acústico. Además, es compatible con los sistemas de suelo radiante. 100% impermeable, es apto para baños y cocinas, así, podemos usar el mismo suelo en toda la casa, sin juntas ni transiciones antiestéticas.

COZY AND COMFORTABLE Walking barefoot on Click&Floor is a really pleasant. Warm and pleasant like natural wood and, at the same time, technical and silent thanks to its acoustic insulation. It is also suitable for underfloor heating. 100% waterproof, you can lay it in bathrooms and kitchens allowing the use of the same floor throughout the house, without joints or unsightly transitions.



DURADERO Y RESISTENTE frente a cambios de temperatura y la luz solar. Su núcleo rígido no transfiere las pequeñas imperfecciones del subsuelo y su capa de desgaste lo protege contra las marcas de muebles pesados y los arañazos, por eso es un suelo ideal para hogares con mascotas.

DURABLE AND RESISTANT to temperature changes and sunlight. Its rigid core does not transfer little subfloor imperfections and its wear layer protects it against heavy furniture marks and scratches, making it an ideal floor for homes with pets.



CUIDA DE TI, CUIDA DEL PLANETA Antibacteriano y libre de plásticos nocivos, un suelo seguro para toda la familia y para el planeta, ya que es 100% reciclable y sostenible. Además, si cambias de casa, lo puedes reutilizar fácilmente.

IT TAKES CARE OF YOU, IT TAKES CARE OF THE EARTH Antibacterial and free of harmful plastics, a safe floor for the whole family and for the planet, as it is 100% recyclable and sustainable. Besides, if you move house, you can easily reuse it.

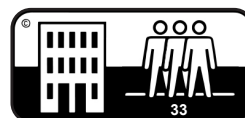

CLICK&FLOOR





RO BLE

Roble, la elección para espacios elegantes y serenos. Atemporal y cálido, su inusual longitud de 184,2cm es perfecta para proyectos de alto nivel.

Oak is the perfect choice for elegant and moderate spaces. Timeless and warm, its unusual length of 184,2cm is valued for high level projects.

ROBLE



Variación leve: diferencias visibles en el aspecto de la superficie y los motivos dentro de un mismo lote de producción

Slight variation: visible differences in surface appearance and motifs within the same production batch



188293 Roble Natural
22,8×184,2 cm./9"×72.5" M943



188291 Roble Tostado
22,8×184,2 cm./9"×72.5" M943



188292 Roble Gris
22,8×184,2 cm./9"×72.5" M943



188290 Roble Miel
22,8×184,2 cm./9"×72.5" M943

FORMAS DE COLOCACIÓN / WAY OF PLACEMENT

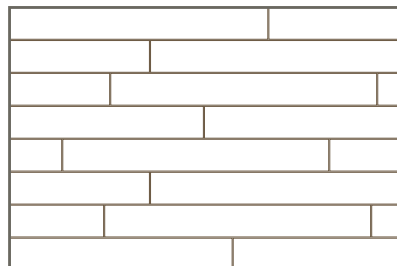
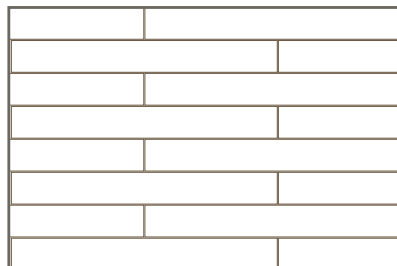

*PERFIL T 4,5x240 cm. D461

- 188302 Perfil T Roble Miel
- 188303 Perfil T Roble Tostado
- 188304 Perfil T Roble Gris
- 188305 Perfil T Roble Natural



* Venta a cajas completas / Sold per complete boxes



Zonelec *line.*





188291 Roble Tostado 22,8×184,2 cm./9"×72.5" M943





188290 Roble Miel 22,8×184,2 cm./9"×72.5" M943



CLICK&FLOOR



SIE RRA

Diseño de aire rústico moderado que destaca por sus tonos neutros y naturales, así como por las marcas de sierra características de su relieve. Con una longitud de 153,2cm es muy versátil tanto para proyectos públicos como privados.

Moderate rustic design, it also suits in urban and commercial environments. It stands out for its neutral and natural tones, as well as for its saw marks characteristics of its relief. With a length of 153,2cm., this is our medium format.

SIERRA



Variación moderada: variación considerable en el aspecto superficial, los motivos y el color entre un azulejo y otro, y dentro del propio azulejo. Es aconsejable visualizar la gama cromática antes de seleccionar el material

Moderate variation: considerable variation in surface appearance, patterns and color from one tile to another and within the tile itself. It is advisable to view the color gamut before selecting the material



188286 Sierra Natural
22,5x153,2 cm./8.9"x60.3" M943



188288 Sierra Gris
22,5x153,2 cm./8.9"x60.3" M943



188287 Sierra Vison
22,5x153,2 cm./8.9"x60.3" M943

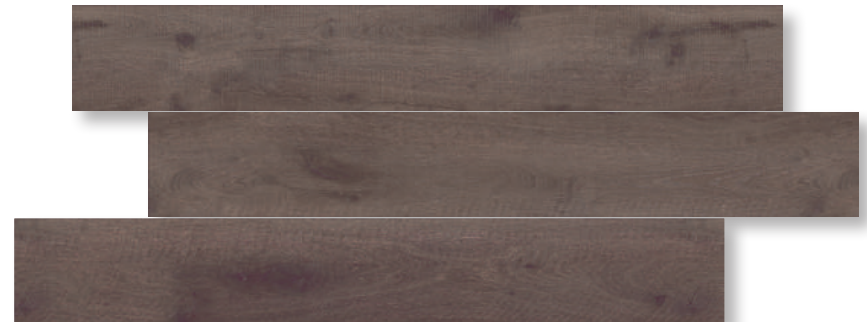

188289 Sierra Carbon
22,5x153,2 cm./8.9"x60.3" M943

FORMAS DE COLOCACIÓN / WAY OF PLACEMENT

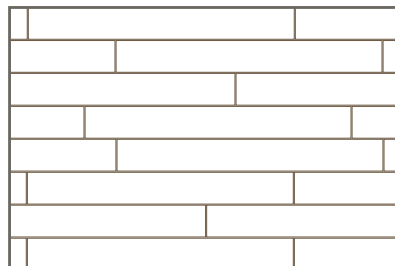
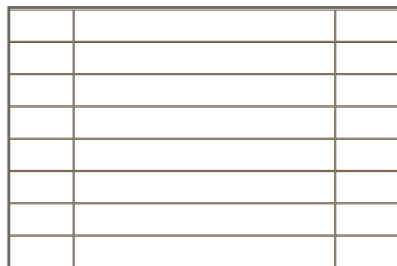

*PERFIL T 4,5x240 cm. D461

- 188298 Perfil T Sierra Natural
- 188299 Perfil T Sierra Visón
- 188300 Perfil T Sierra Gris
- 188301 Perfil T Sierra Carbón



* Venta a cajas completas / Sold per complete boxes







188288 Sierra Gris 22,5x153,2 cm./8.9"x60.3" M943







CLICK&FLOOR



MUL TI NO GAL

Nogal, elegante y suave, es nuestra serie más dinámica gracias a sus lamas de tres anchos diferentes. Su longitud de 123,5cm es óptima para espacios pequeños, aunque también queda genial en espacios grandes.

Elegant walnut wood design, it stands out because it is served in three different widths that comes mixed to create very dynamic floors. Its length of 123,5cm is very suitable for small places, although it can also be used in big areas as well .

MULTI NOGAL



Variación moderada: variación considerable en el aspecto superficial, los motivos y el color entre un azulejo y otro, y dentro del propio azulejo. Es aconsejable visualizar la gama cromática antes de seleccionar el material

Moderate variation: considerable variation in surface appearance, patterns and color from one tile to another and within the tile itself. It is advisable to view the color gamut before selecting the material



188284 Multi Nogal Claro
12,5/17,8/22,5X123,5 M943

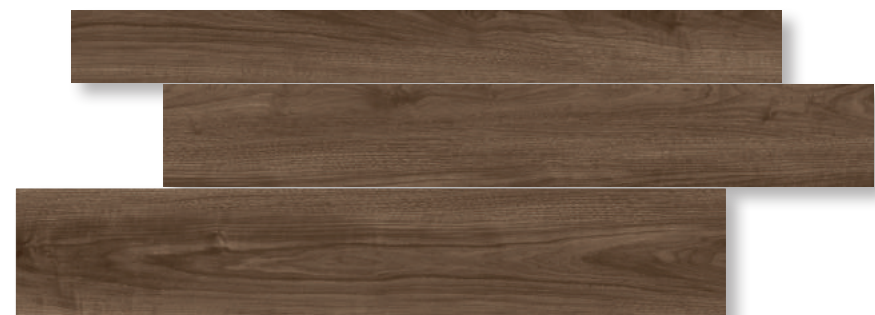

188285 Multi Nogal Oscuro
12,5/17,8/22,5X123,5 M943

FORMAS DE COLOCACIÓN / WAY OF PLACEMENT

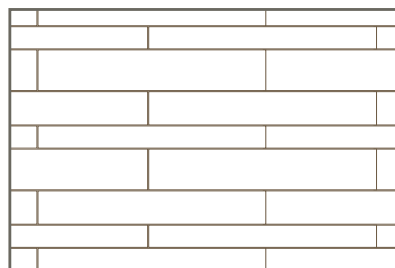
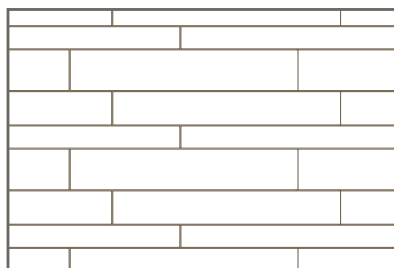

Packing Multi Nogal
3 pcs. 12,5 x 123,5 cm.
6 pcs. 17,8 x 123,5 cm.
3 pcs. 22,5 x 123,5 cm.

*PERFIL T 4,5x240 cm. D461

188296 Perfil T Nogal Claro
188297 Perfil T Nogal Oscuro



* Venta a cajas completas / Sold per complete boxes









CLICK&FLOOR



CHE VRON

Nuestra propuesta más pequeña para suelos en forma de espiga, muy típica del parquet clásico. Destaca por sus tonos claros de madera decapada, con sus nudos blanquecinos, ideal para ambientes acogedores.

Our smallest proposal for herringbone-shape compositions, very typical of parquet floor. It stands out for its light tones of pickled wood, with its characteristic whitish grains, for serene and pleasant environments.

CHEVRON



Variación moderada: variación considerable en el aspecto superficial, los motivos y el color entre un azulejo y otro, y dentro del propio azulejo. Es aconsejable visualizar la gama cromática antes de seleccionar el material

Moderate variation: considerable variation in surface appearance, patterns and color from one tile to another and within the tile itself. It is advisable to view the color gamut before selecting the material



188295 Chevron Blanco
14,6x73 cm./5.7"x28.7" M962



188294 Chevron Natural
14,6x73 cm./5.7"x28.7" M962

FORMAS DE COLOCACIÓN / WAY OF PLACEMENT

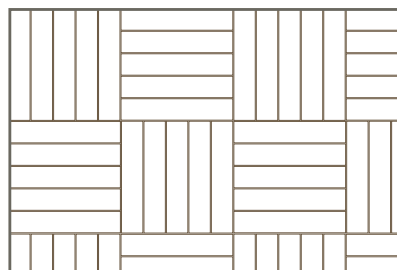
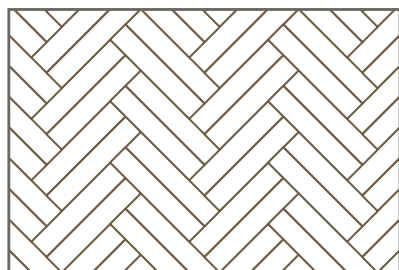

Packing Chevron
11 pcs. Right
11 pcs. Left



*PERFIL T 4,5x240 cm. D461
188306 Perfil T Chevron Natural
188307 Perfil T Chevron Blanco

* Venta a cajas completas / Sold per complete boxes



188340 Rodapié Flexi 8x200 **D582**

188295 Chevron Blanco 14,6x73 cm./5.7"x28.7" **M962**





A TENER EN CUENTA

Instalar C&F es fácil y rápido aunque requiere seguir atentamente las instrucciones. Una instalación incorrecta anulará la garantía del producto. Inspeccione el material y compruebe que los bordes estén rectos y sin daños. No se aceptarán reclamaciones de defectos superficiales después de la instalación. A efectos estéticos, recomendamos colocar las tablas perpendiculares a la ventana y mezclar el contenido de las distintas cajas antes de la instalación. Por favor consulte atentamente las instrucciones detalladas de colocación que encontrará en las cajas del producto y en la ficha técnica de nuestra web.

KEEP IN MIND

Installing C&F is quick and easy, although it requires to follow the instructions carefully. Incorrect installation will void the product warranty. Check the material and make sure that the edges are straight and undamaged. Claims for surface defects after installation will not be accepted. For aesthetic reasons, we recommend placing the boards perpendicularly to the window and mixing the contents of the different boxes before installation. Please carefully consult the detailed installation instructions that are to be found in the product boxes and in the technical sheet on our website carefully.



vídeo de colocación



installation video

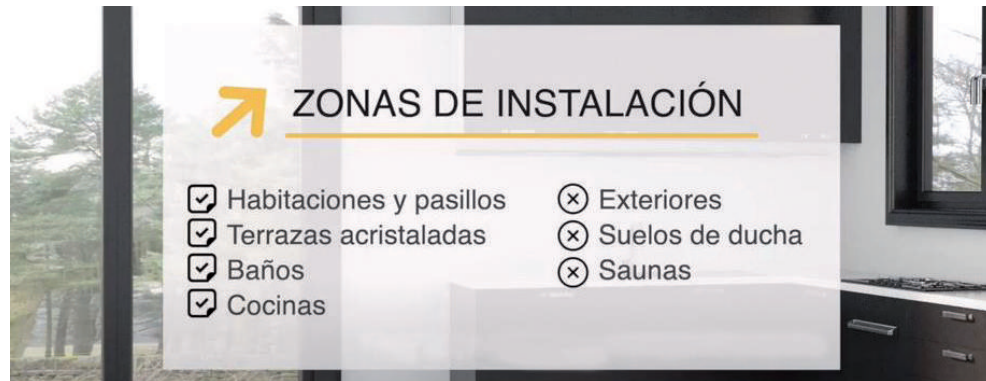

Installation areas: 3-Season room, sunrooms, bathrooms, kitchen, outdoor, shower areas, saunas.



Los sistemas de calefacción deben estar instalados a un mínimo de 12mm. de separación con el producto. La temperatura no debe exceder nunca los 30°C. / Embedded radiant heat systems must have a minimum of 12 mm. separation from the product. Maximum operating temperature should never exceed 30°C.



Herramientas: espaciadores, martillo de goma, regla, lápiz, metro, cúter, taco de goma, pegamento de vinilo premium y aguarrás. / **Tools:** spacers, rubber mallet, ruler, pencil, tape measure, utility knife, tapping block, premium vinyl adhesive and mineral spirits.



El suelo debe ser estructuralmente firme, estar limpio, seco y nivelado a 5mm en un radio de 3 metros. En suelos de cemento se recomienda usar una capa aislante de polietileno min 0,15 mm. / Subfloor must be structurally sound, clean, dry and levelled to 5mm within a 3 m. radius. For concrete subfloor we recommend using a polyethylene layer of at least 0.15mm/6mil as a moisture barrier.

Consejos de instalación Click&Floor / *Click&Floor installation advices*



Calcule la superficie de la habitación antes de la instalación y planee un 5% extra de producto para contar con los residuos provocados al cortar. No necesita aclimatación. / *Calculate the room surface prior to installation and allow an extra 5% of flooring for cutting waste. Acclimatization is not required. Make sure that the temperature in the room is maintained constant between 20/25°C - 70/80°F before and during the installation. After the installation temperature must be between -15/60° - 5/140°F.*



Inspeccione el material para comprobar daños o defectos visibles. Una vez la instalación se haya completado no se aceptarán reclamaciones. / *Inspect material for visible faults or damage. No claims on surface defects will be accepted after installation.*

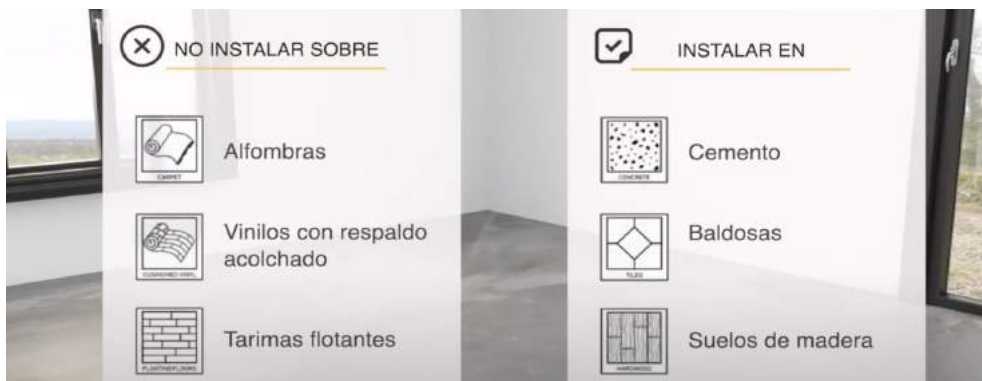

*Do not install over: carpet, cushion-backed vinyl and floating floors.
 Install over: concrete, tiles and wooden floors.*



Use espaciadores de 6mm entre cualquier objeto fijo (paredes, armarios, etc.) y el producto. En cuartos de baño, dejar 10 mm de separación y rellenar con un sellante de silicona. / *Use 6 mm. spacers between any fixed object (wall, cabinets, etc...) and the product. In bathrooms, leave a space of 10 mm. between the object and fill it with a silicone sealant.*



Coloque la primera tabla de forma que la lengüeta del click quede mirando en dirección contraria a la pared. / *Place the first plank so that grooved edges are facing away from the walls.*



Use el martillo de goma para golpear justo encima de las juntas de las tablas y encajarlas perfectamente. ATENCIÓN: un golpe sobre la junta incorrectamente alineada podría dañar la articulación. / *Make sure that the planks fit together using of a mallet and a rubber block. ATTENTION: a blow to the incorrectly aligned joint could damage the edges.*

Consejos de instalación Click&Floor / *Click&Floor installation advices*

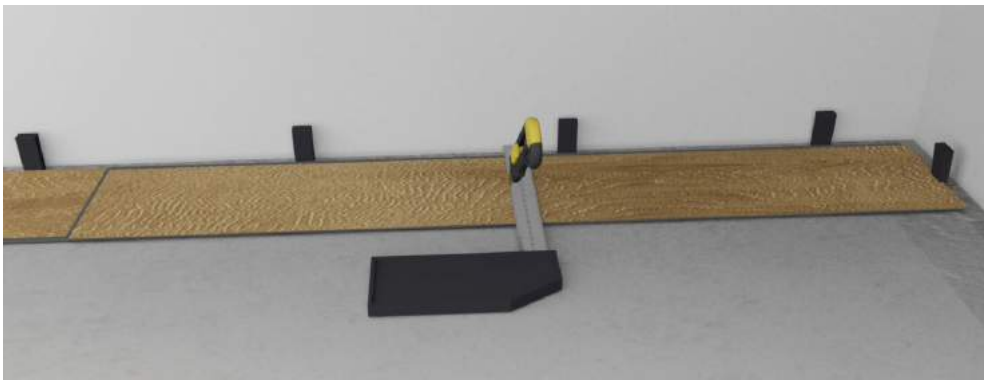

Utilizar el cúter para cortar las tablas. / *Use utility knife to cut the planks.*

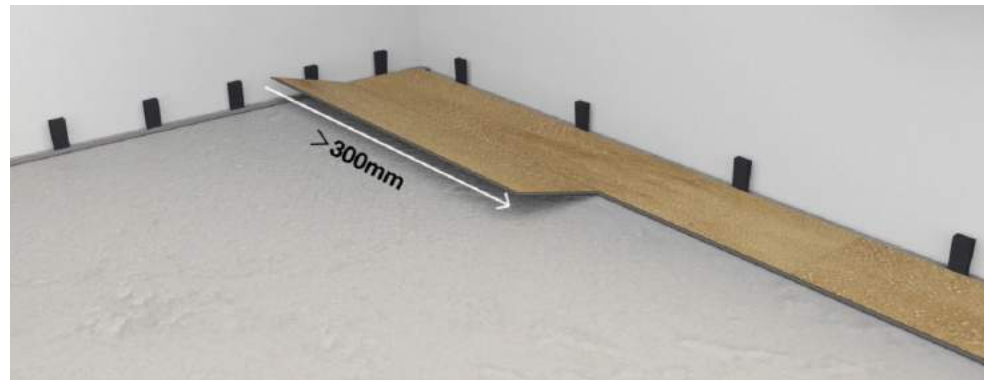

Segunda fila, primer tablón: Comience la segunda fila con la parte cortada del último tablón de la fila anterior. Este pieza debe medir al menos 300 mm / 12". / *Second row, first plank: Start the second row with the cut part of the plank of the previous row. This small plank should measure at least 300 mm/12".*

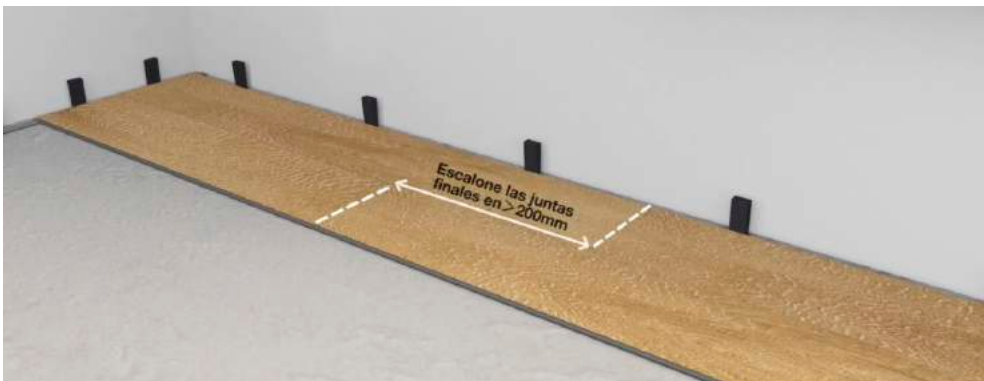

Escalane las juntas finales en al menos 200 mm. / *Stagger end joints at least 200 mm.*



Use un martillo y un taco de goma para golpear suavemente en los lados largos de las piezas, asegurándose de que los clicks de las filas anteriores están completamente encajados. / *Use a tapping block and a rubber mallet to gently tap the long sides of the planks into the click of the previous row to make sure they are fully engaged.*



Puertas y rodapiés: Coloque un tablón (con el lado decorativo hacia abajo) al lado del marco de la puerta como se muestra en la figura. Luego deslice el tablón debajo del marco. / *Door moulding and skirt boards: Lay a plank (with the decorative side down) next to the door moulding and saw as shown in the figure. Then slide the floorboard under the moulding.*

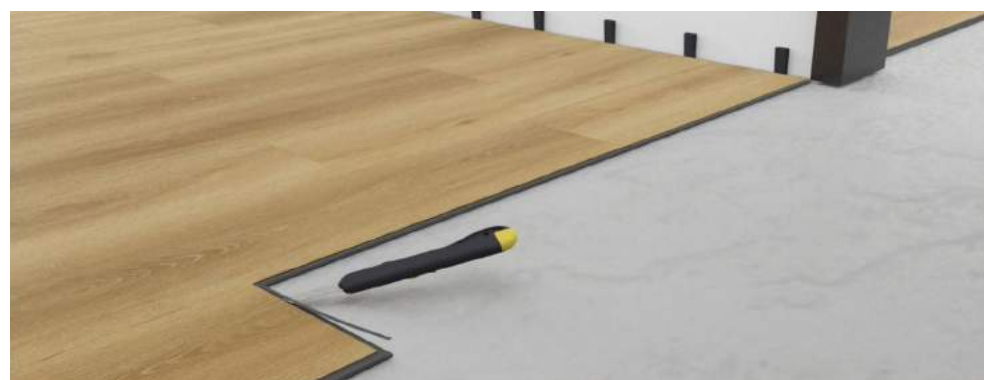

Corte el borde de las ranuras de las tablas adyacentes. / *Cut off the lip on the groove of the adjacent planks.*

Consejos de instalación Click&Floor / *Click&Floor installation advices*



Aplique una fina capa de pegamento. / *Apply a thin bead of adhesive.*



Tuberías: Mida el diámetro y perforo un agujero 12mm. más grande. Corte un trozo, y ponga la pieza recortada en su lugar. / *Holes for pipes: Measure the diameter of the pipe and drill a hole that 12mm/1/2" larger. Saw a piece and lay the plank in place on the floor. Then lay the sawed piece in place.*



Mida el área sobre la que se va a instalar, el ancho de la última fila no debe ser menor a 50 mm., en caso contrario, ajuste el ancho de la primera fila antes de comenzar la instalación / *Measure the area to be installed; the width of the last row should not be less than 50mm. If so, adjust the width of the first row to be installed.*



Islas de cocina: No instale la isla directamente sobre el producto. La calidad del producto puede garantizarse siempre y cuando éste pueda moverse libremente. / *Kitchen island: Do not install your kitchen island directly over your floor. The floor's quality can be guaranteed as long as the floor can be moved freely.*



No necesita molduras en forma de "T" en las puertas / *No T-molds required in doorways.*



En cuartos de baño dejar 10mm. de junta de expansión y rellenar con silicona. / *Be sure to leave 10 mm. expansion gaps and fill them in with a premium silicone-based sealant.*

ESPECÍFICO PARA LA SERIE MULTI NOGAL / SPECIFIC FOR MULTI NOGAL SERIES

Nota: En cada fila DEBE usarse una lama de ancho de 6.9" / 176 mm. Debe seguirse esta secuencia a lo largo de toda la instalación.

Note: In each row **MUST** be used a 6'5" / 176mm mould. This sequence must be followed along the whole installation.

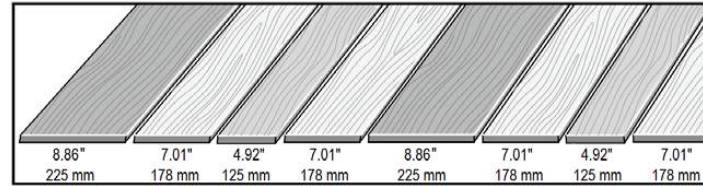
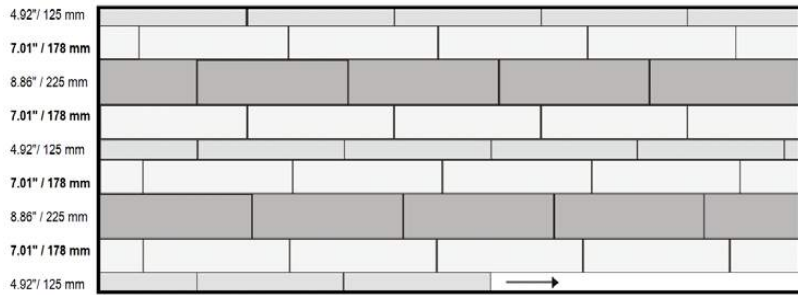

ESPECÍFICO PARA LA SERIE CHEVRON / SPECIFIC FOR CHEVRON SERIES

MÉTODO 1 – PATRÓN DE BLOQUES / BLOCKS PATTERN

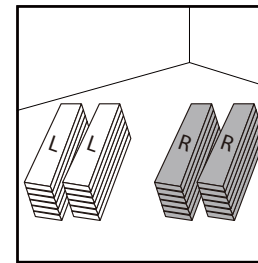
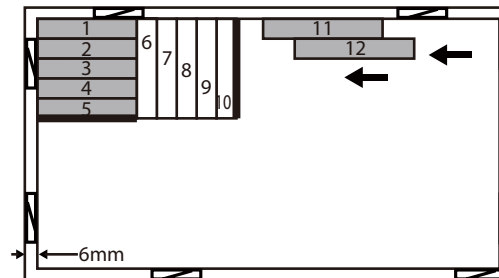
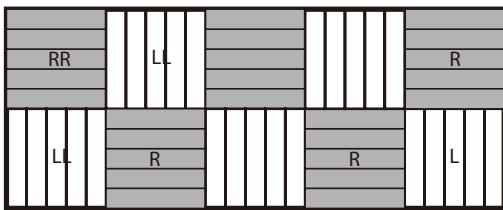

Separar en diferentes montones ayudará a identificar el tablón correcto en caso de que las marcas de L y R se hayan eliminado.

Separating in different piles will help you to identify the correct plank in case that the L and R marks have been erased.

MÉTODO 2 – ESPINA DE PESCADO EN DIAGONAL / FISHBONE DIAGONAL PATTERN

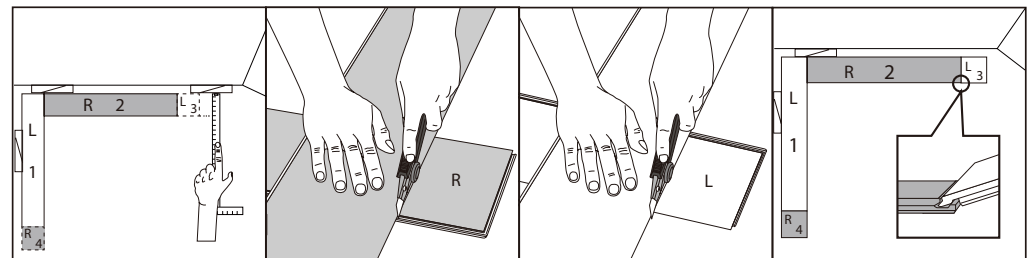
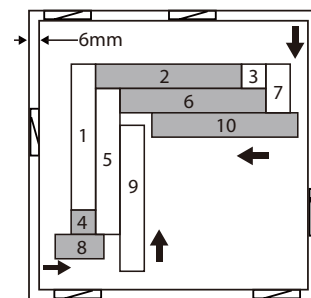
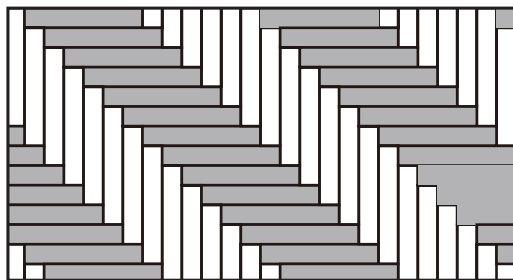

Esta secuencia es un ejemplo, dependerá de la forma que tenga la habitación. Lo importante es empezar siempre con los tablones que están colocados contra las paredes.

This sequence is an example, as it will depend on the shape of the room. The important thing is to always start with the planks that are placed against the wall.

MÉTODO 3 – PATRÓN DE ESPINA DE PESCADO / FISHBONE PATTERN

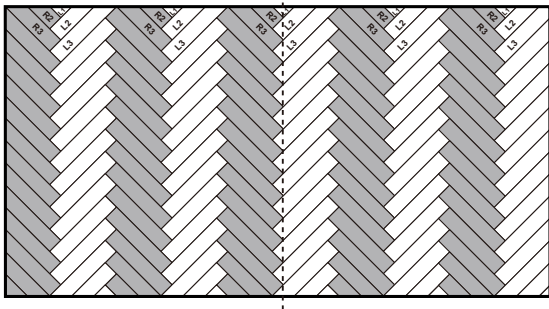

Al principio, siga la plantilla de corte del interior de la caja para cortar 5 tablones (L1, L2, L3, R1, R2) necesarios para el primer set. Sólo puede cortar una pieza de cada tablón, por lo que necesitará 5 tablones enteros para hacer las 5 piezas requeridas (L1, L2, L3, R1, R2). Alinee el set inicial con la línea central (para alinear los tablones asegúrese de que la línea pasa por la punta del patrón). Deje siempre un margen de expansión de 6mm / 1/4" con la pared.

At the beginning, follow the cutting template that comes inside the box to cut 5 planks (L1, L2, L3, R1, R2) needed for the first set. You can only cut one piece of each plank, so you will need 5 entire planks to make the 5 required pieces (L1, L2, L3, R1, R2). Align the starting set with the central line (to align the planks make sure that the line passes through the tip of the pattern). Always leave an expansion margin of 6mm/1/4" with the wall.

SET INICIAL / STARTING SET

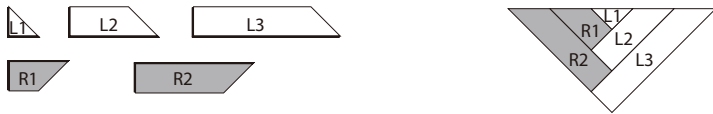

Mida cuantos sets iniciales necesita basándose en la anchura de la habitación. Prepare los sets iniciales adicionales. Puede conectar los sets iniciales con un tablón entero.

Measure how many starting sets you need based on the width of the room. Prepare the additional starting sets. You can connect the starting sets with an entire board

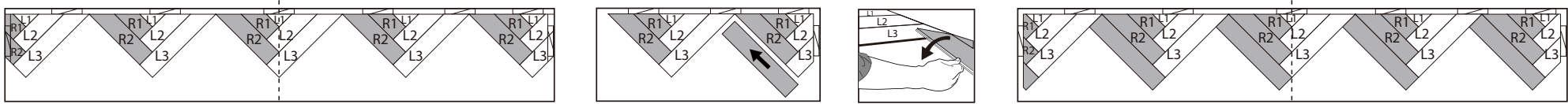

Cuando llegue a ambos lados de las paredes, mida la distancia entre la pared y el set inicial más cercano. Arme un nuevo set, marque la distancia medida en él, corte los tablones (para esto puede desarmar el set) e instale los tablones en el hueco restante.

When you reach to both sides of the wall, measure the distance between the wall and the closer starting set. Assemble a new set, mark the distance measure, cut the planks (you can disassemble the set for this) and install the planks in the remaining gap.

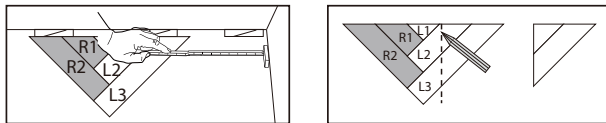

Continúe así hasta que la habitación este completamente cubierta.
Continue until the room is completely covered.

Utilice la plantilla de corte del interior de la caja para dibujar el set inicial de 5 piezas del Chevron doble. (L1, L2, L3, R1, R2). Sugerimos usar un lápiz rojo para hacer una plantilla de acuerdo a la siguiente tabla:

Use the cutting template inside the box to draw the double Herringbone 5-piece starting set. (L1, L2, L3, 1, R2). We recommend using a red pencil to make a template according to the following table:

Tablón / Plank	Lado de la ranura / Groove side	Lado de la lengüeta / Tongue plank
L1	146 mm	0 mm
L2	292 mm	146 mm
R1	438 mm	292 mm
R2	584 mm	438 mm
L3	730 mm	584 mm

Sólo puede cortar una pieza de cada tablón, por lo que necesitará 5 tablones enteros para hacer las 5 piezas requeridas (L1, L2, L3, R1, R2). Alinee el set inicial con la línea central (para alinear los tablones asegúrese de que la línea pasa por la punta del patrón). Deje siempre un margen de expansión de 6mm / 1/4" con la pared.
You can only cut one piece of each plank, so you will need 5 entire planks to make the 5 required pieces (L1, L2, L3, R1, R2). Align the starting set with the central line (to align the planks make sure that the line passes through the tip of the pattern). Always leave an expansion margin of 6mm/1/4" with the wall.

SET INICIAL / STARTING SET

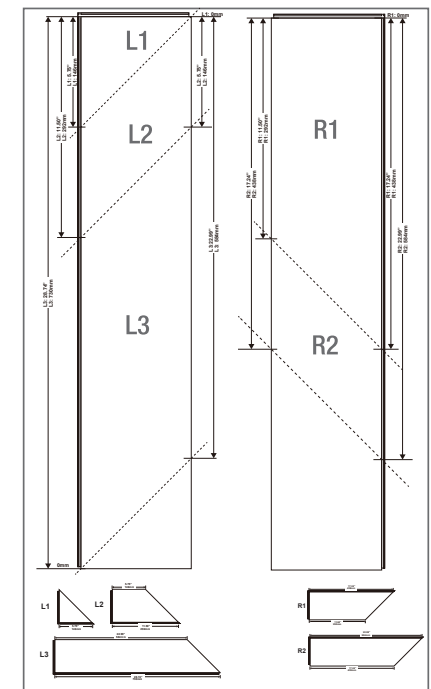

MÉTODO 4 – CHEVRON DOBLE / DOUBLE FISHBONE PATTERN

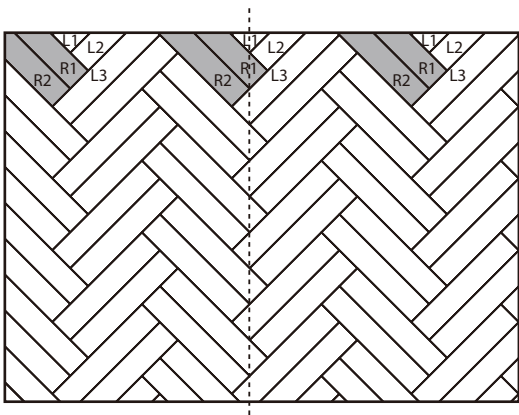

SET INICIAL / STARTING SET

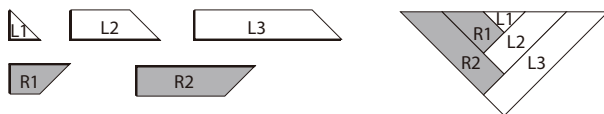

Mida cuántos sets iniciales necesita basándose en la anchura de la habitación. Prepare los sets iniciales adicionales. Puede conectar los sets iniciales con un tablón entero.

Measure how many starting sets you need based on the width of the room. Prepare the additional starting sets. You can connect the starting sets with an entire board.

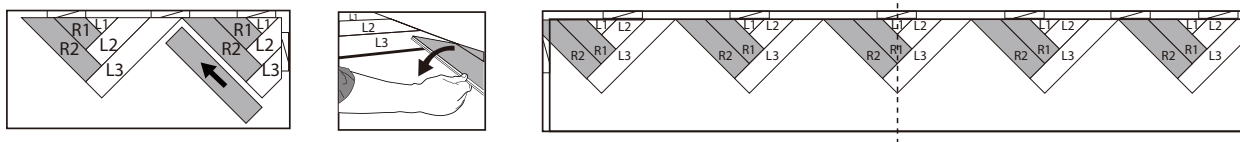

Cuando llegue a ambos lados de las paredes, mida la distancia entre la pared y el set inicial más cercano. Arme un nuevo set, marque la distancia medida en él, corte los tablonces (para esto puede desarmar el set) e instale los tablonces en el hueco restante.

When you reach to both sides of the wall, measure the distance between the wall and the closer starting set. Assemble a new set, mark the distance measure, cut the planks (you can disassemble the set for this) and install the planks in the remaining gap.

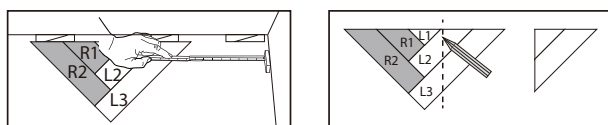

Continúe así hasta que la habitación este completamente cubierta.

Continue until the room is completely covered.

DESMONTAJE / DISASSEMBLING

Para desmontar, simplemente levante los tablonces uno a uno siguiendo la secuencia inversa de instalación.

To disassemble, lift the planks one by one following the inverse sequence of the installation.

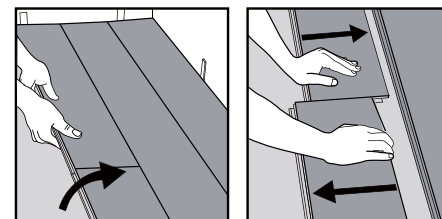

INSTALACIÓN EN BAÑOS (JUNTA 10mm.) / BATHROOM INTALLATION (GAP 10mm.)

Con azulejos preexistentes en pared /
With preexisting wall tiles



Dejar 10mm. de junta de expansión, rellenar con silicona y cubrir con una moldura escocia. / *Leave 10mm. expansion joint, fill with silicone and cover with a scotch molding.*

Con nuevos azulejos en pared /
With new wall tiles



Coloque los azulejos de la pared a una altura de 6mm. Coloque también junta perimetral de 10 mm. entre la pared y C&F. Rellenar el hueco con silicona y colocar la tabla bajo el azulejo. Rejuntar. / *Lay the wall tiles at a height of 6mm. Also place 10mm perimeter gasket between wall and C&F. Fill the gap with silicone and place the board under the tile. Grout.*

RODAPIÉ FLEXI

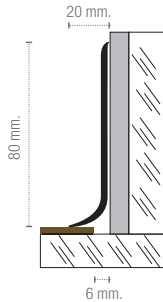

188340 Rodapié Flexi 8x200 D582

Flexi es un rodapié fabricado en PVC semi flexible. Combina las excelentes propiedades de resistencia del PVC rígido con un grado de flexibilidad idóneo para su adaptación a paredes irregulares o ligeramente curvas. Su remate en escocia facilita la limpieza, evitando la acumulación de gérmenes. Muy adecuado para cubrir las juntas perimetrales. Fácil de instalar, se pega a la pared con cola de contacto o adhesivo para pvc, descansando sobre C&F sin aprisionarlo. Es perfecto para reformas y obra nueva.

Flexi is a profile made of semiflexible PVC intended to be placed as a skirting in all kind of walls. It combines the excellent properties of rigid PVC with the appropriate degree of flexibility, which allows its installation in irregular walls or smooth curves.

Its geometry, which ends with a smooth curve, makes easier the cleaning, avoiding the accumulation of germ. Also useful to cover the typical expansion joints in perimeters. Easy to install, glued to the wall with contact glue or adhesive for pvc, laying on C&F without pressing it. This profile is perfect for new or reform works and also for projects.

PERFIL T



Para superficies mayores de 400m² usar nuestros perfiles de "T".
For areas bigger than 400m² our "T" moldings are needed.

PELDAÑOS / STEPS









En el mercado existen soluciones específicas para productos de vinilo SPC, como los de la marca Schluter.

In the market there are specific solutions for SPC vinyl steps, such as those of the Schluter brand.

CLICK&FLOOR VS OTROS SUELOS

	C&F SPC	LUXURY VINYL	WPC	LAMINADO
100% impermeable <i>100% waterproof</i>	✓	✓	✓	X
Estable contra cambios bruscos de temperatura <i>Stable against sudden temperature change</i>	✓	X	X	✓
Estable a la luz solar directa <i>Stable to direct sunlight</i>	✓	X	X	✓
No necesita perfiles de transición en puertas <i>It does not need transition profiles in doors</i>	✓	X	✓	X
Muy resistente a las marcas por impacto y peso de muebles <i>Very resistant to impact marks and furniture weight</i>	✓	X	X	✓
No necesita aclimatación <i>It does not need acclimation</i>	✓	X	✓	X
No marca las pequeñas irregularidades del subsuelo <i>It does not mark the little irregularities of the subfloor</i>	✓	X	✓	✓
Apto para todas las habitaciones <i>Suitable for all rooms</i>	✓	X	X	X
Requiere muy poca preparación del subsuelo <i>It requires very little subfloor preparation</i>	✓	X	✓	✓
Fácil de instalar <i>Easy to install</i>	✓	X	✓	X
Absorbe los sonidos <i>It absorbs sounds</i>	✓	X	✓	X
Muy bajas emisiones de VOC <i>Very low VOC emissions</i>	✓	✓	✓	X
TOTAL:	100%	16%	67%	42%

EMBALAJE / PACKAGING

							
CHEVRON	9,38	22	19,80	43,65	44	2,34	102,96
MULTI NOGAL	4,88	12	22,00	48,50	44	2,46	108,20
ROBLE	2,38	5	17,50	38,58	60	2,10	125,99
SIERRA	2,90	7	20,30	44,75	48	2,41	115,82
PERFIL T	-	20	12,50	27,56	72	-	-
RODAPIE FLEXI	-	8	5,76	12,70	45	-	-

CÓDIGOS DE VENTA / SALES CODES

D	Venta a pieza	Sold per piece	Vendu à l'unité	Verkauf Stückweise	Vendita al pezzo	Продается по м2	بيع بالقطعة
M	Venta en m² y a cajas completas	Sold per sqm in complete boxes	Vendu au m2 et boîte complète	Verkauf per m² und per Verpackungseinheit	Vendita a m² e scatola piena	Продается по м2 и кратно коробкам	وبالعلب الكاملة بيع بالمتر المربع

SÍMBOLOS DE EMBALAJE / PACKAGING SYMBOLS

	ES	EN	FR	DE	IT	RU	AR
	Pieza /m²	Piece /sqm	Pièce/m²	Stück /m²	Pezzo/m²	Штуки/м2	قطعة /m²
	Piezas /caja	Pieces /box	Pièces /carton	Stück /Schachtel	Pezzi/scatola	Штук /коробка	قطعة/الكرتون
	Kg /caja	Kg /box	Kg /carton	Kg /Schachtel	Kg/scatola	Кг /коробка	وزن الكرتون / بالكيلوغرام
	Libras /caja	Lbs /box	Livre /carton	Lbs /Schachtel	Lb/scatola	фунты /короба	وزن الكرتون /Lbs
	Cajas /pallet	Boxes /pallet	Cartons /palettes	Schachteln /Palette	Scatole/pallet	коробки/паллет	كرتون / اللوحه
	m² /caja	Sqm /box	m² /carton	m² /Schachteln	m² /scatola	м² /поробка	م² / كرتون
	m² /pallet	Sqm /pallet	m² /palette	m² /Palette	m² /pallet	м² /паллет	م² / اللوحه

© Copyright DUNE CERAMICA S.L. Reservados todos los derechos.

Catálogo General - Abril 2021 - Impresión: Logui Impresión

Las fotografías de ambiente de este catálogo son imágenes de inspiración.

Para conocer los usos y características de cada producto, consulte la ficha técnica en la web www.duneceramics.com

Dune Cerámica se reserva el derecho de modificar las características de sus productos sin preaviso de ningún tipo.

Los acabados se dan a título indicativo, quedando bajo reserva los ajustes de los colores consecuencia de las técnicas de impresión.

Por ello, las fotografías de los productos expuestos no son contractuales. La interpretación de las ilustraciones estará en función del criterio del creador.

Los textos que aparecen en el catálogo quedan bajo reserva de posible error por composición o inserción de página.

Este catálogo es meramente informativo.

© Copyright DUNE CERAMICA S.L. All rights reserved.

General Catalogue - April 2021 - Printed by Logui Impresión

The ambience-setting images on this catalogue are only inspirational pictures.

For technical and use information of each product, please consult the datasheet on our website www.duneceramics.com

Dune Cerámica reserves the right to change the characteristics of its products without prior notice.

Information about the finishes of the goods is only provided as a guide.

As a result of the printing techniques, there might be differences between the colours printed in this catalogue and those of the real products.

Colours shown in this catalogue are not contractual. The images are for illustration purpose only and are subject to the designers interpretation.

This catalogue is for information purposes only.

www.duneceramics.com



ESPAÑA - Oficinas Centrales/Headquarters
Partida Rachina s/n, 12130 - San Juan de Moró(Castellón)
Tel.:+(34) 964 657 400 - Fax:+(34) 964 657 401
dune@dune.es - www.duneceramics.com